



www.sanlidaarchery.com
www.sanlidaoutdoor.com



DRAGON X8
OWNER'S MANUAL

Safety

- This is one powerful bow, so you must take upon the responsibility of using it. Please ensure your shooting area is clear and smooth as well there won't be any persons come into it by accident.
- Be sure the weight of arrow is no less than 5 grain per your bow's peak weight. (1 grain = 0.0648g).
- Inspect before every shot to ensure no damage on arrows.
- · Shoot the arrows with suitable length to prevent the arrow fall down from the arrow rest when draw the bow back.
- Please check your bow regularly, and stop using it when found any bow parts damaged.
- Never aim any other peoples or other subjects except your target.
- Use the correct shooting pose to prevent the arm injure by the string.
- Never dry fire! As it would damage the bow and hurt to the shooter.
- Please notice the surroundings and ensure the enough shooting space to use the bow.
- No permission for illegal using of the bow.

Maintenance

- Some necessary maintenance needed by the bow, and take care of the process of doing it, especially for some fitting parts like string, cable slide, limbs, limb pocket, bow handle, cams and cable slide rod etc. Pay much attention to the damage caused by colliding with other objects and incorrect maintenance action.
- The string and cable should be replaced one year later or several hundreds of shots. Stop using and replace the strings as soon as the splitting strands occurred on the string. Rub some of bee wax and string wax into the string each week.
- Please clear the dust on the bow and pay much attention to the cam. Please make drying of it if it's wet and never heat it for drying.
- No lubrication needed on the cam and axle. Otherwise, we recommend making some lubrication during shooting in rainy day.
- Inspect periodically to ensure no loosening screws. Change the wear screw if any.
- Don't stock your bow in any wet condition and heat source, including putting in the car during sunny day. Make the careful inspection before every shooting to ensure no loosen and broken screws. Inspecting all fitting parts to ensure no broking and lost, especially the small parts like cable slide, bow limb shock-absorbing rubber washer, fixing screws etc. Check your bow for preventing the bow from parts broken caused by incorrect stocking of it.

Dragon X8 Component Diagram

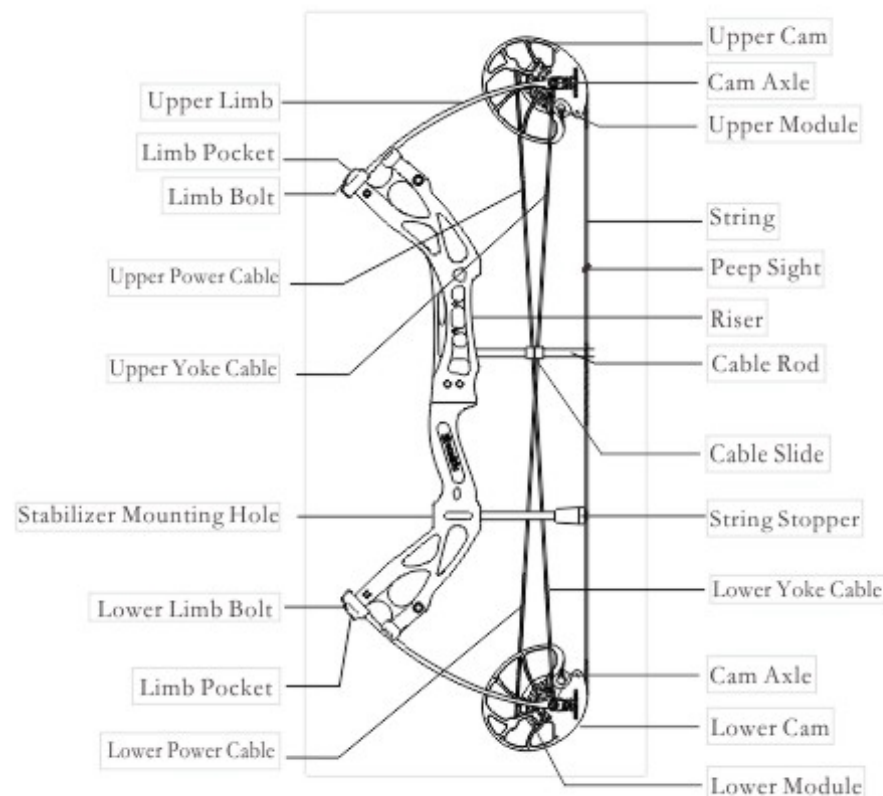

Cam System

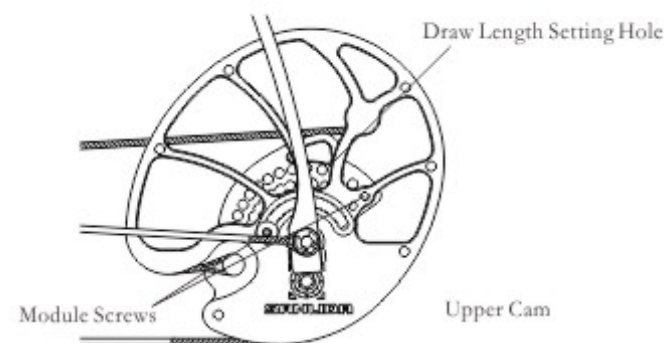

Fig.1

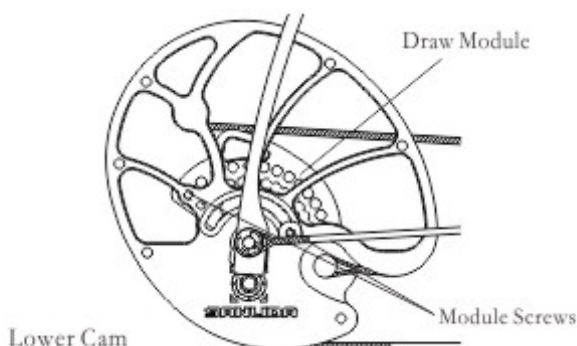

Fig.2

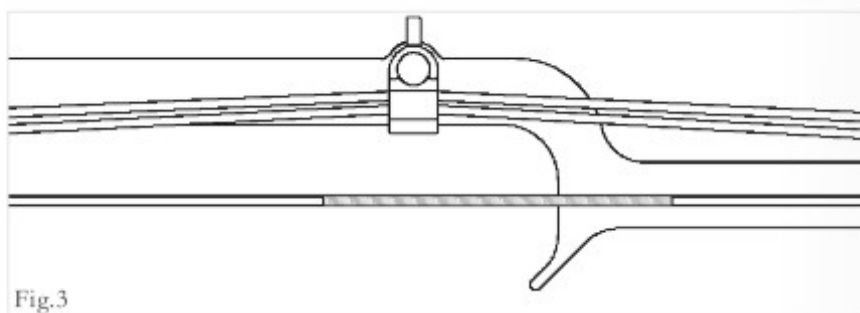

Fig.3

Cross of Cables

- This bow is with the Dual-Cam system.
- The Dual-Cam system could make draw length adjustment by rotating the cam module to different positions. The string assembling should be symmetrical between the top and the lower. There are different grooves on the cable slide to prevent the mutual wear between 2 cables. (Fig. 3)

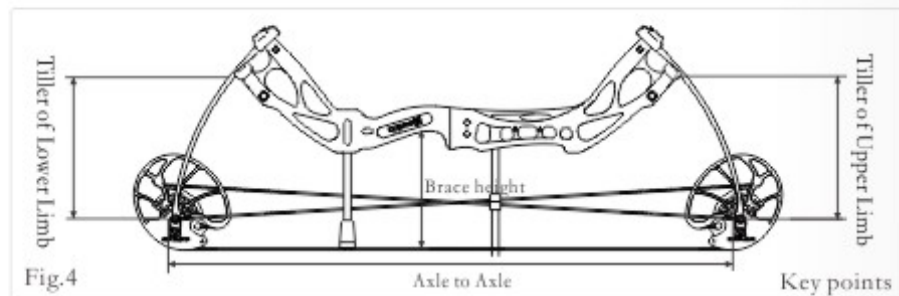

Fig.4

Axle to Axle: The length of the bow from the center of one cam axle to the other cam axle.

Brace Height: The distance between the string and the pivot point of the grip (deepest position of the grip).

Tiller is a measurement of the distance between the top limb (rear face) and string as it compares to the same measurement of the bottom limb(rear face) and string. (See fig. 4)

Bow Press Tool

- It is necessary to make sure the initial setup of the Axle -to -Axle , brace height, cam after the entire bow string is installed and adjusted. This will ensure the performance of the bow can be fully exerted.
- The cam synchronization means the bow string hit the draw stop peg on the upper and the stop peg of lower cams simultaneously to complete the stop motion of the cam while full draw of the bow.
- When the upper cam and lower cam do not hit on the bow string at the same time, it means that the upper cam and lower cam do not rotate synchronously. This is cams non-synchronization.
- The bow may not be synchronized after attaching accessories. If bare bow installed with different accessories, it may also cause slight cams non-synchronization. So we recommend that a bow is only used by one person.
- When the upper cam and lower cam are out of synchronization, the length of the bow string needs to be adjusted (see the following instruction for the bow adjustment method). Now , it is time for you to use the bow press. Here is an introduction of how to use the bow press as following:

- It' s very important to use bow press correctly.
- Choose the correct bow press to make sure that the string and cables can be taken out easily when compressing the bow.
 - The limb is not allowed to be pressed against the supporting pole.
 - For a split bow limb, the bifurcations of the bow press should seize the end of the limb, which will help to prevent the slipping out of the bow while compressing the limbs. The bifurcations of the bow press also should have the proper length to allow the rotation of the cam when compressing the bow.
 - The bow limb must be accurately leaned on the bifurcation of the bow press without twist on the limb for avoiding the falling off of the bow from the bow press and cause injury. (Fig.5)
 - Do not excessively bend the bow . To avoid abnormal bow bending, resulting in damage or broken bows and other serious accidents.
 - Do not attempt to use the bow press without proper training.



Draw weight Adjustment

The draw weight of this bow can be adjusted.

· When adjusting draw weight every time, it will be heavier when tune the limb bolt clockwise, will be lighter when tune the limb bolt counterclockwise. Tuning one circle, the draw weight varies about 3-5lbs.

When adjusting draw weight, the upper limb bolt and lower limb bolt must be adjusted at same circles. Then measure the vertical distance from the string to limb pocket bolt, that is, projection distance of limb. If the projection distance of the upper limb are the same as the projection distance of the lower limb, that is, adjustment of upper limb and the adjustment of lower limb are the same. Then when the bow is drawn, the upper and lower cams should be synchronized.(Fig. 6) Do not back the limb bolt too much when decreasing the draw weight. Please notice the limb bolt from the peep hole, stop loosening the bolt when the end of the bolt shows in the peep hole.

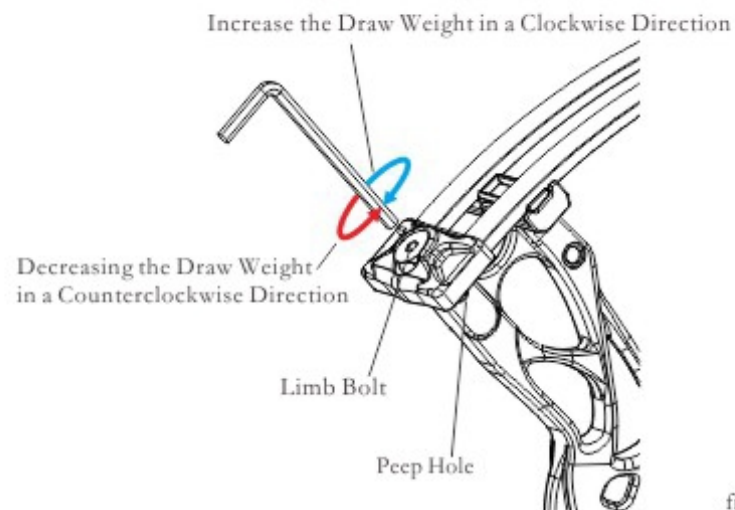

Adjustment of the draw length

To adjust the draw length, loosen the module screws first, adjust the upper and lower modules to the same fixing holes to ensure they are in the same position, (Fig.7&Fig.8), then fixed the module screws. The draw weight adjustment can be completed.

The upper and lower cams must be in the same fixing holes to ensure the same positions.

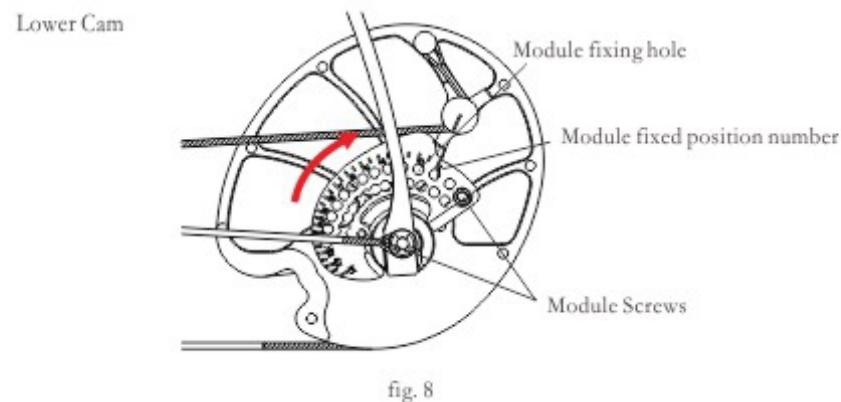
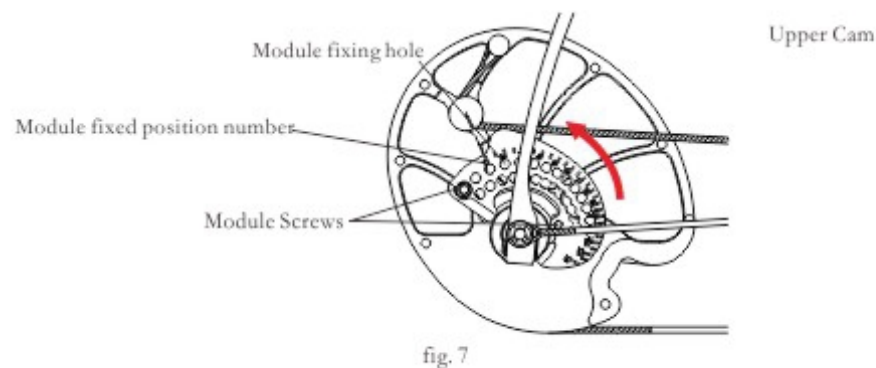

Correspondence Table
- Between Module Fixed Positions, Draw Lengths and Draw Weights -

Module Fixed Position Numbers	Maximum Draw Weight(70# Bow as the Sample)	IBO Draw Length (Inch)
1	70.0	31
1.5	69.8	30.5
2	69.4	30
2.5	68.9	29.5
3	68.4	29
3.5	67.7	28.5
4	66.8	28
4.5	66.4	27.5
5	65.0	27
5.5	63.7	26.5
6	62.4	26
6.5	61.3	25.5
7	59.8	25
7.5	58.3	24.5
8	57.4	24
8.5	55.3	23.5
9	53.8	23
9.5	51.9	22.5
10	50.2	22
10.5	48.8	21.5
11	48.8	21
11.5	48.6	20.5
12	48.6	20

12.5	48.6	19.5
13	48.4	19
13.5	48.4	18.5
14	48.4	18

Adjust the bow

Compound bow can shoot accurately or not, the greatest impact is the synchronization of compound bow, in addition to the factors of human operation.

When the string stop at the draw stoppers of both cams (Upper cam and Lower cam) at the same time, and the cams can not rotate, we call that is synchronization. (Fig. 9) If the string stop at any one draw-stopper of the cams (Upper cam and Lower cam), the other cam do not touch the string, that means this compound bow is out of synchronization., we need to adjust the cable to get synchronization.

The best way to adjust the compound bow synchronization is after you install the accessories, because the bare bow synchronization will be changed a little out of synchronization and change center of gravity of the bow after you install the accessories.

Situation 1 : When the axle to axle is longer, the lower power cable is attached to the cam draw stopper, but the upper power cable is not.

Solution: Twist the lower power cable. 3mm will be adjusted smaller on the gap between the power cable and groove by each circle.

Situation 2 : When the axle to axle is shorter, the lower power cable is attached to the cam draw stopper, but the upper power cable is not.

Solution: Loosen the upper power cable, 3mm will be adjusted smaller on the gap between the power cable and groove by each circle.

Situation 3 : When the axle to axle is longer, the upper power cable is attached to the cam draw stopper, but the lower power cable is not.

Solution: Twist the upper power cable. 3mm will be adjusted smaller on the gap between the power cable and groove by each circle.

Situation 4 : When the axle to axle is shorter, the upper power cable is attached to the cam draw stopper, but the lower power cable is not.

Solution: Loosen the lower power cable, 3mm will be adjusted smaller on the gap between the power cable and groove by each circle.

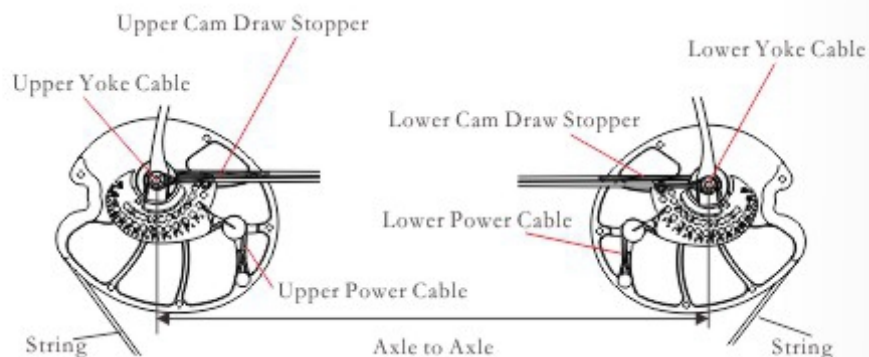

fig. 9

Install the accessories

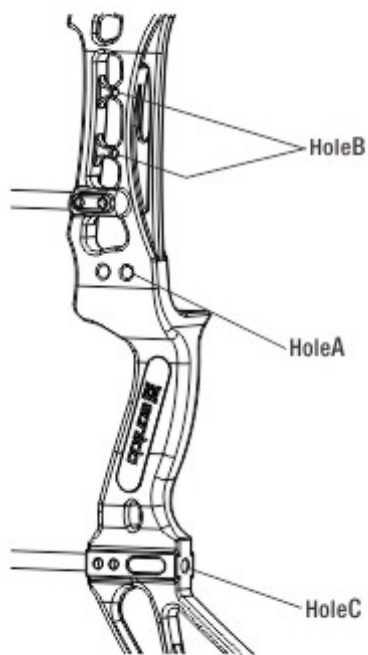

fig. 10

The bow was setting with international standard holes for bow accessories .(Fig. 10)

Arrow Rest: There are standard screw holes for arrow rest (Hole A). The lower edge of bracket for arrow rest should be parallel with the sight window.

Bow Sight: There are standard holes and hole gap for bow sight (Hole B), which can be fitted for all types of bow sights in the market.

Stabilizer: Hole C is for fixing the stabilizer, which is also the fixing screw hole for bow sling.

Product Specification

Axle to Axle (inch)	30"
Brace Height (inch)	6.5"
Draw Weight (lbs)	0~60lbs; 0~70lbs;
IBO Draw Length (inch)	18"~31"
Color	Vista Camo;Black
IBO Speed (Fps)	310
Let-off	70%~80%